

The Antley CAT bulkhead is the perfect luminaire for any industrial and outdoor installation where precise illumination is required. Being available in a surface mount or stirrup mounted for floodlighting makes this a high quality and versatile luminaire.

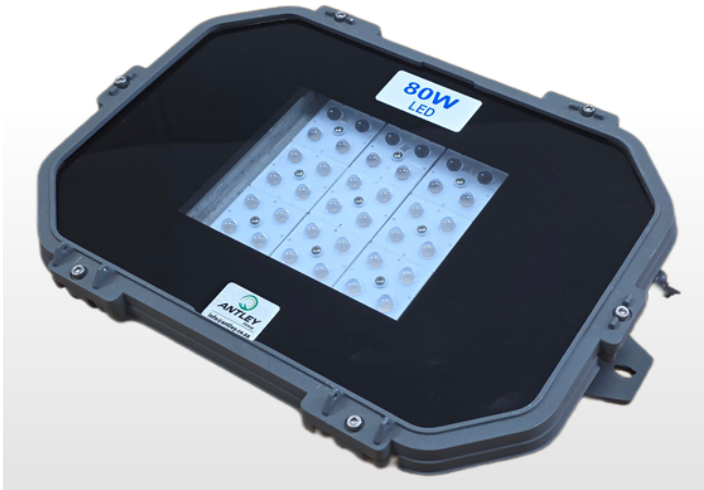

Materials and Finish

- Die-cast aluminium body and trim ring
- Tempered glass diffuser

Features

- IP66 Ingress protection for LED panel
- Stainless steel clips for ease of access/maintenance
- Stainless steel fasteners
- 10kV/kA surge protection

Wattages

- 68W
- 100W
- 120W
- 150W

Installation

- Surface or Stirrup mounted

Application areas

- Industrial
- Area lighting
- Bay lighting
- Outdoor

Colours

- Black
- White
- Grey

Dimensions

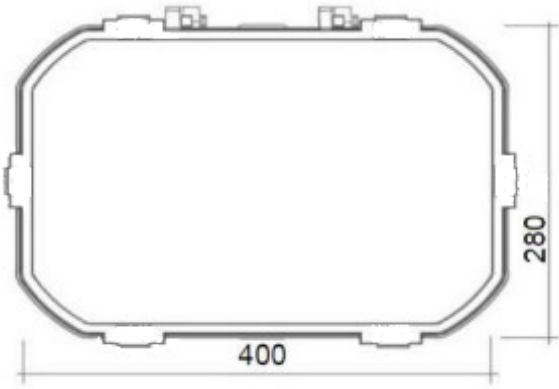

Beam angles

110

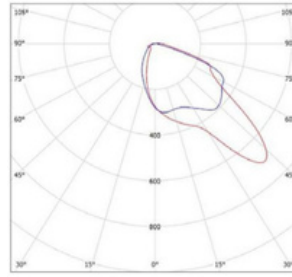

111

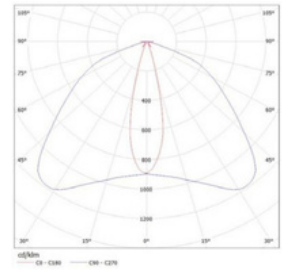

112

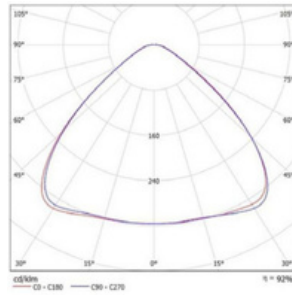

113

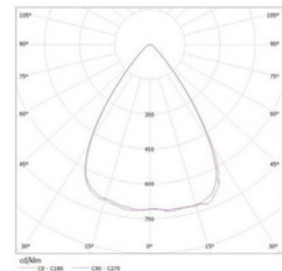

114

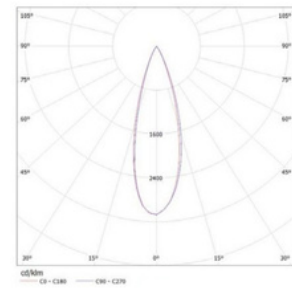

115

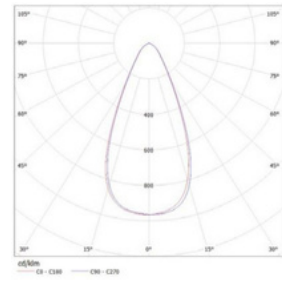

Ordering data

Full product name	Lumens	Battery Backup
• CAT 68W	11684	20% - 3 hours
• CAT 100W	16420	10% - 3 hours
• CAT 120W	19240	10% - 3 hours
• CAT 150W	22300	10% - 3 hours

Accessories

- Wall bracket
- Floodlight stirrup
- Battery back up (20% output maintained for 3 hours)

Colour temperatures

- 4000K (standard)
- 5000K (on request)